

2018.0 RANGE ROVER (LG), 100-00

GENERAL INFORMATION

FIRST RESPONDER (G2257073)

DESCRIPTION AND OPERATION

RESCUE SHEET

	Range Rover (L405) Range Rover Sport (L494) PHEV 2018 Onwards
---	--

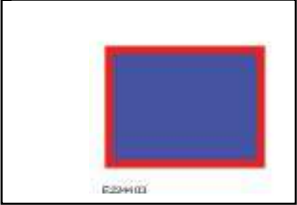
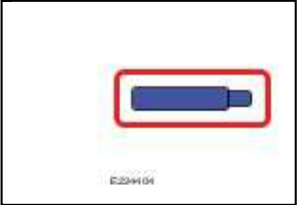
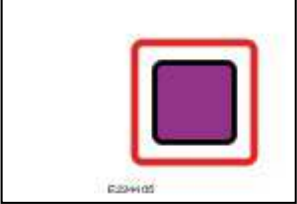
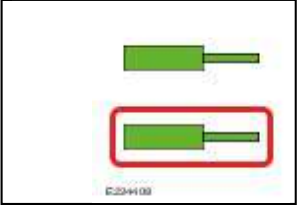
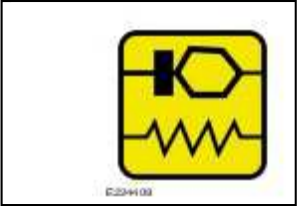
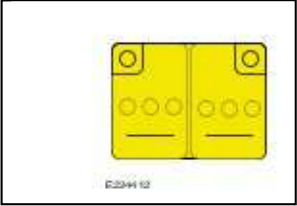

E229900en

ITEM	DESCRIPTION
 <p>E2344 03</p>	Airbag
 <p>E2344 04</p>	Airbag inflator/ stored gas inflator
 <p>E2344 05</p>	Seatbelt pretensioner
 <p>E2344 08</p>	Gas strut/Preloaded spring
 <p>E2344 09</p>	SRS control unit
 <p>E2344 12</p>	Battery, low-voltage

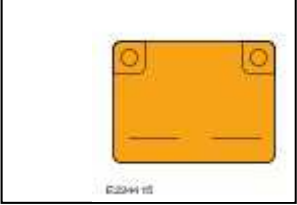
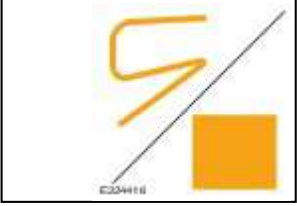
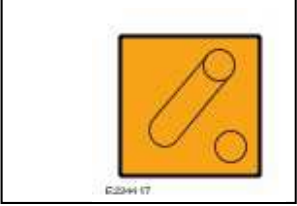
ITEM	DESCRIPTION
 <p data-bbox="316 405 363 421">E2344 14</p>	<p data-bbox="1082 197 1182 226">Fuel Tank</p>
 <p data-bbox="316 728 363 743">E2344 15</p>	<p data-bbox="1002 519 1262 548">High-voltage battery pack</p>
 <p data-bbox="316 1052 363 1068">E2344 16</p>	<p data-bbox="943 842 1321 871">High-voltage power cable/ component</p>
 <p data-bbox="316 1373 363 1388">E2344 17</p>	<p data-bbox="1011 1164 1252 1193">High-voltage disconnect</p>

IDENTIFICATION OF THE VEHICLE MODEL AND SPECIFIC VERSION

All Range Rover and Range Rover Sport models can be identified as a PHEV by the following key features:

Front grill has an opening panel on the left side.



Behind the grill opening panel is the PHEV charge port.



The center console has an Electric Vehicle (EV) button to engage and deactivate EV mode.



Unique P400e badges.



AVOIDANCE OF ROLL AWAY OF THE CRASHED VEHICLE

The vehicle may roll if the transmission does not lock or the park brake is inoperable. The road wheels should be chocked to prevent unexpected movement.

Vehicle lifting and jacking points can be found as shown in the illustration.

WARNING:

Make sure that no contact is made between the lifting equipment or any high voltage components.

The jack or lift support must be positioned centrally on the locations shown to provide a safe vehicle weight distribution and avoid vehicle damage.

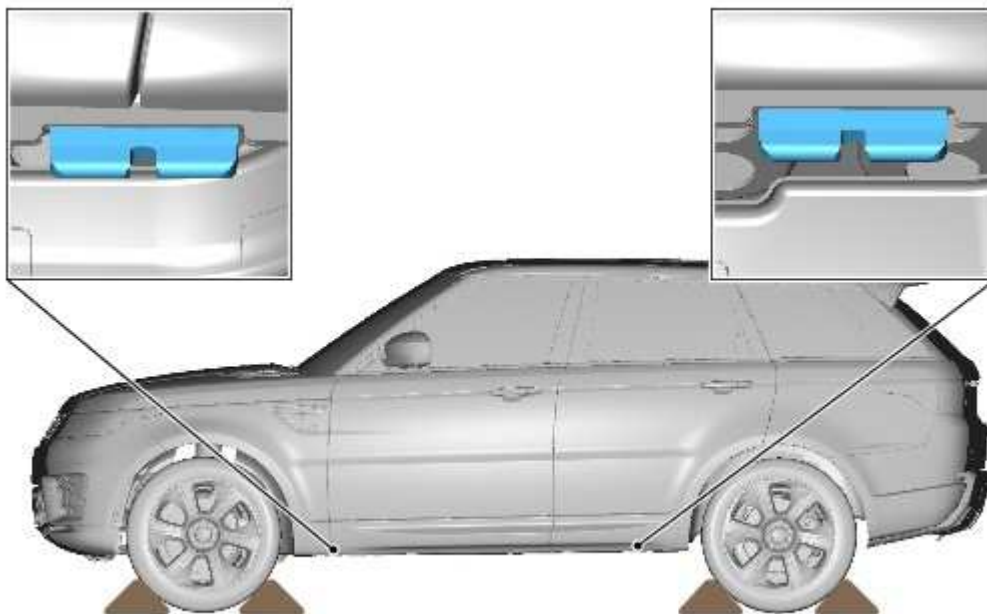

E224656

DISCONNECTING THE STARTUP BATTERY

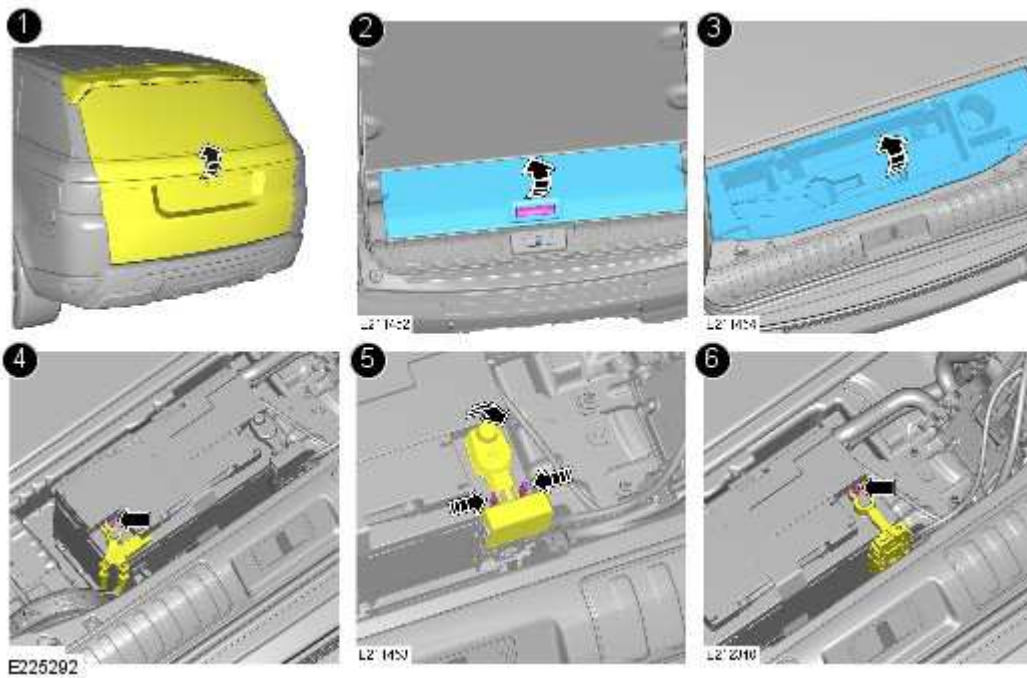

ITEM	DESCRIPTION
1	Open the vehicle tailgate
2	Remove the loadspace floor panel
3	Remove the tool kit tray
4	Disconnect the startup battery ground cable
5	Remove the startup battery positive terminal cover
6	Disconnect the startup battery positive cable

DISCONNECTING THE AUXILIARY BATTERY

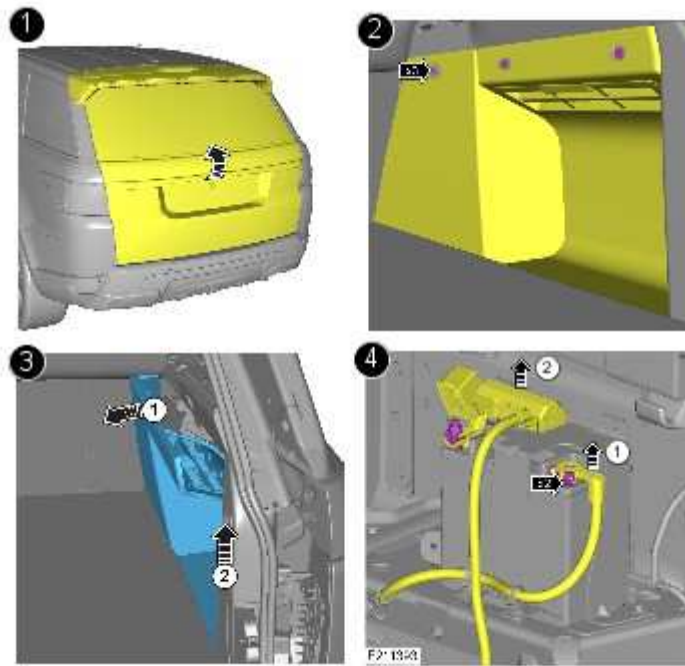

E225293

ITEM	DESCRIPTION
1	Open the vehicle tailgate
2	Release the 3 clips for the right loadspace trim panel
3	Remove the right loadspace trim panel
4	<p>WARNING:</p> <div style="border: 1px solid red; padding: 5px; text-align: center;"> Make sure the auxiliary battery ground cable is disconnected first. </div> <ul style="list-style-type: none"> ▪ Disconnect the auxiliary battery ground cable ▪ Disconnect the auxiliary battery positive cable

DEACTIVATING OF HIGH VOLTAGE SYSTEM

In an emergency, removing the Manual Service Disconnect (MSD) from the top of PHEV battery will isolate the HV system.

WARNING:

All persons must wear appropriate Personal Protective Equipment (PPE) when handling components within the vehicle High Voltage system

Vehicles without Business Seats

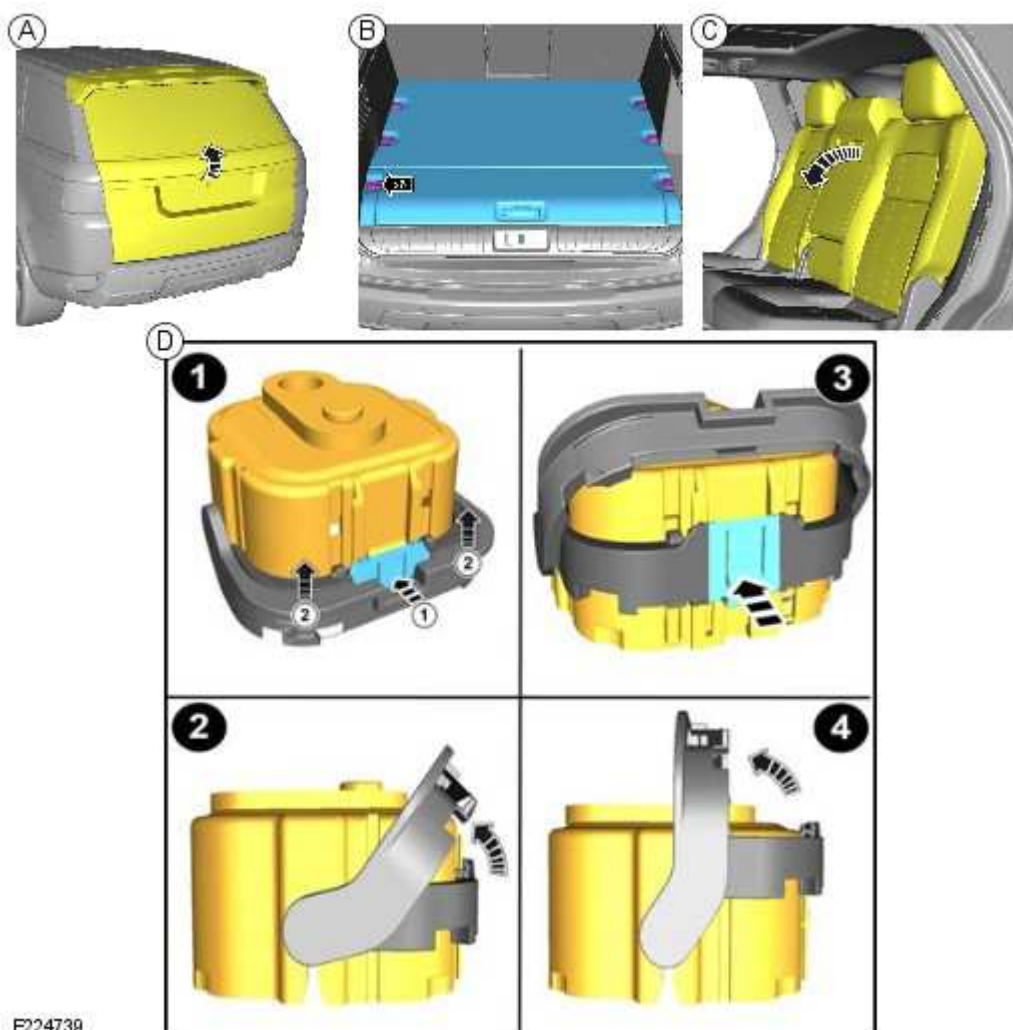

Vehicles with Business Seats (Excluding Range Rover SVA)

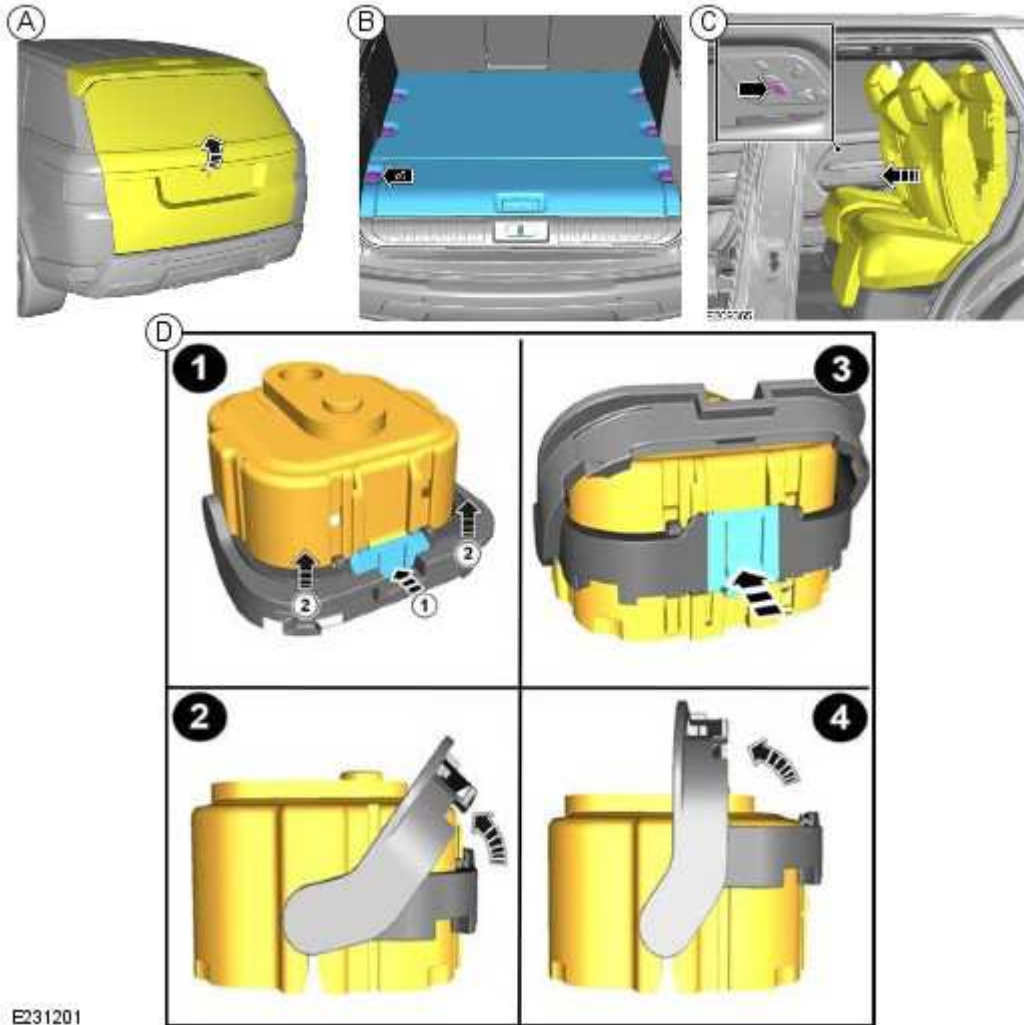

E231201

ITEM	DESCRIPTION
A	Open the vehicle tailgate
B	Remove the loadspace floor
C	Fold down the rear seats
D	Remove the MSD using the 4 stage process shown

Vehicles with Business Seats (Range Rover SVA Only)

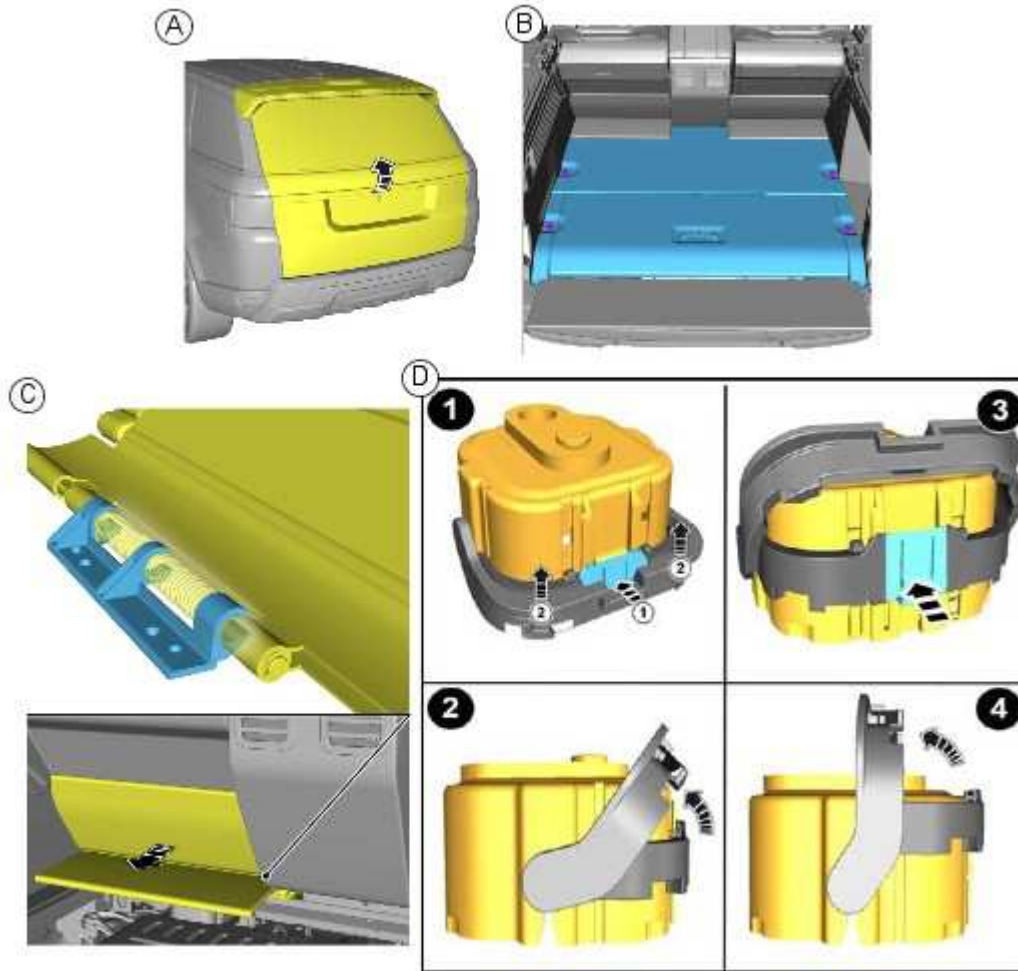

E233163

ITEM	DESCRIPTION
A	Open the vehicle tailgate
B	Remove the loadspace floor
C	Remove the left gap hider
D	Remove the MSD using the 4 stage process shown

ADDITIONAL INFORMATION FOR RESCUING

The areas highlighted in RED show areas that must not be cut.

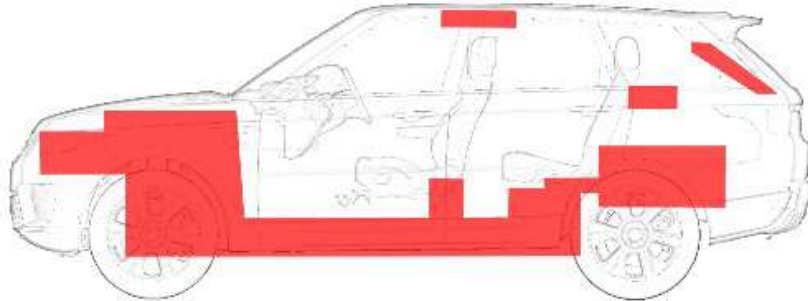

E224662

The sills must be supported during cutting and extrication procedures. If a ram must be deployed, place blocks under the sill around the area where force is applied. If a suitable jacking point cannot be located, support the sills and deflate the tires.

ADDITIONAL INFORMATION IN CASE OF FULLY OR PARTIALLY SUBMERGED VEHICLE

A Plug-in Hybrid Electric Vehicle (PHEV) that has experienced complete or partial submersion in water can be treated in the same manor as other vehicles, the vehicle body does not present an increased risk.

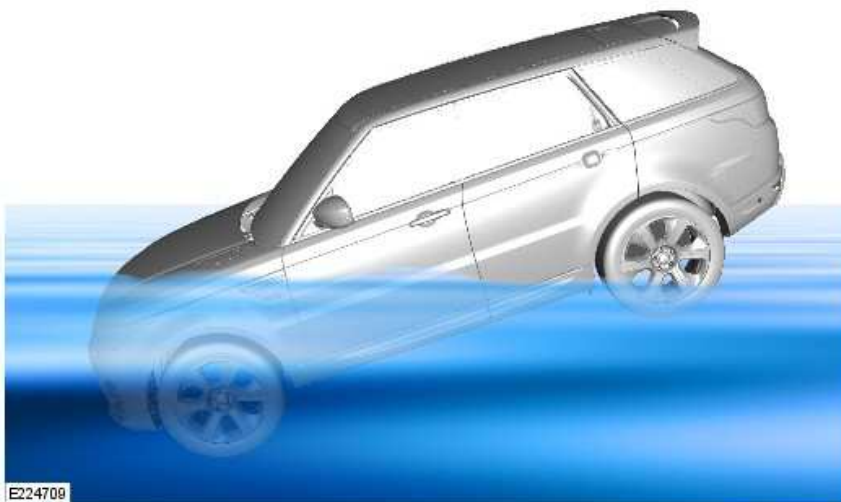

E224709

Persons handling the recovery of a PHEV must wear appropriate **PPE**, as detailed by your local authority, until the High Voltage (HV) system has been correctly powered down.

ADDITIONAL INFORMATION IN CASE OF A FIRE

Small vehicle fires that do not involve the High Voltage (HV) system can be treated with normal firefighting methods.

High Voltage (HV) System Exposure

An PHEV battery involved in a fire, or exposed to high heat levels, will release toxic vapors. These vapors include sulfuric acid, oxides of carbon, nickel, lithium, copper, and cobalt. Responders must protect themselves with full **PPE** and **breathing apparatus** and consider other persons in the surrounding areas.

The PHEV battery consists of lithium-ion cells. These cells are considered dry cells. If damaged, only a small amount of fluid can leak. Lithium-ion battery fluid is clear in color.

The High Voltage (HV) system has it's own coolant which is typically glycol based coolant. If the system is damaged, this orange coolant can leak out of the high voltage battery or surrounding components.

A damaged PHEV battery can create rapid heating of the battery modules. If you notice smoke coming from the EV battery or surrounding components assume the vehicle is **UNSAFE** and contact Emergency services for further assistance.

High Voltage (HV) Battery Fire

If the PHEV battery or components within the High Voltage (HV) system are subject to fire or high heat levels, the HV system must be treated as **UNSAFE** and therefore sufficient **PPE** must be worn and any contact with the vehicle is to be avoided. Areas exposed to fire or high heat must be treated using high volumes of water, **DO NOT** attempt to extinguish a HV system fire without sufficient water supply. Wait for the correct Emergency services if required.

Battery fires can take up to 24 hours to extinguish. Consider allowing the battery to burn while protecting the surrounding areas.

MISCELLANEOUS INFORMATION

High Voltage System and Driveline Layout

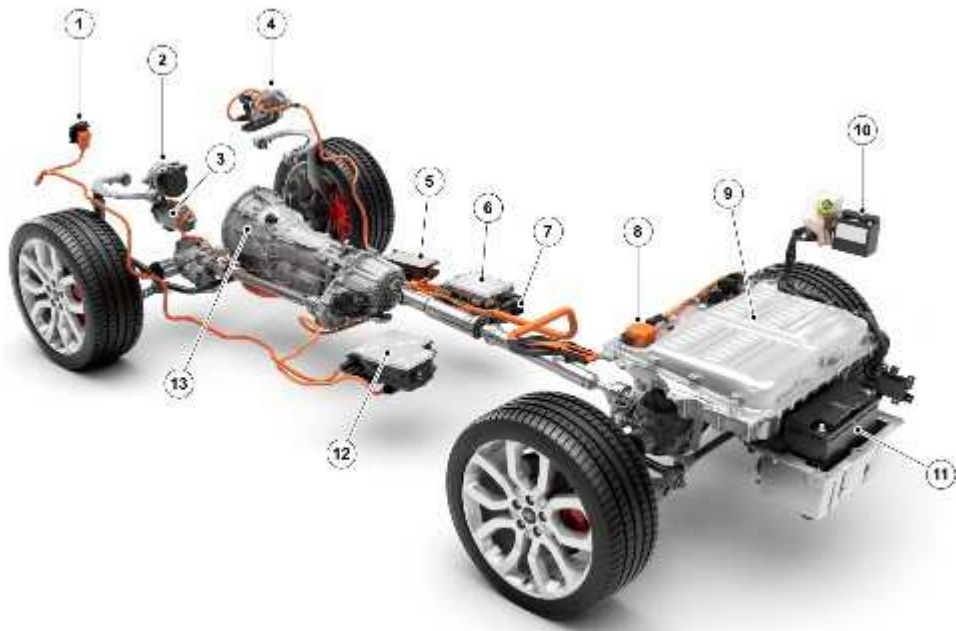

E224730

ITEM	DESCRIPTION
1	Charging Port - HV System
2	Generator
3	Air Conditioning (AC) Compressor - HV System
4	High Voltage Booster Heater - HV System
5	High Voltage Junction Box (HVJB) - HV System
6	DC/DC Converter (high voltage to low voltage) - HV System
7	Electronic Power Inverter Converter (EPIC) - HV System
8	Manual Service Disconnect (MSD) - HV System
9	PHEV Battery - HV System
10	Auxiliary Battery
11	Startup Battery
12	Battery Charger Control Module (BCCM) - HV System
13	Motor Generator (MG) - HV System